

ArtNet-DMX512 Controller User's Manual



(Please read through this manual carefully before use)

1、Brief Introduction

This ArtNet-DMX512 controller is dedicated to converting the ArtNet signal into DMX512 signal, output DMX512 signal, built-in test mode, SD record/play function, timer, etc.

2、Specification

Model	ArtNet-DMX512 Controller
working voltage	DC9V (With adapter)
Input Ethernet control protocol	ArtNet
Output DMX512	4CH DMX512 signal
Working Temp	-20~55°C
Product dimension	L145×W78.4×H29.4(mm)
Weight	410g

3、Basic features

- With LCD screen, easy to operate.
- Support Ethernet DMX512 protocol ArtNet.
- Support online firmware upgrade.
- Built-in test mode, SD record/play function.
- Support 8 timing play, 16 recording effects.
- Support maximum capacity Micro SD8G memory card (equipped).
- Use a DMX output with indicator,easy to operate.

1

4、Safety warning

- Please don't install this controller in lightning, intense magnetic and high-voltage fields.
- To reduce the risk of component damage and fire caused by short circuit, make sure correct connection.
- Always be sure to mount this unit in an area that will allow proper ventilation to ensure a fitting temperature.
- Check if the voltage and power adapter suit the controller.
- Don't connect cables with power on, make sure a correct connection and no short circuit checked with instrument before power on.
- Please don't repair without permission. Please contact supplier if problems occur.
The manual is only suitable for this model; any update is subject to change without prior notice.

5、Dimension

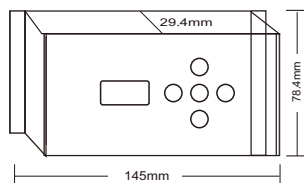

6、Operating instructions

1. Instruction of the interface and ports:

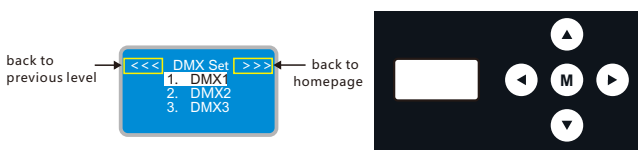

2. Key Description

Button	Short Press Function	Long Press unction
▲	Increase/move the cursor up	Rapid increase
▼	Decrease/move the cursor down	Rapid decrease
▶	Light up/move the cursor right	/
◀	Dim/move the cursor left	/
M	Confirm Button	Unlock the screen

Back to previous level: using ◀▶ move to <<<, then press M key
Back homepage: using ▶▶ move to >>>, then press M key

2

3、Operating and setting instructions

1. Instruction of interface

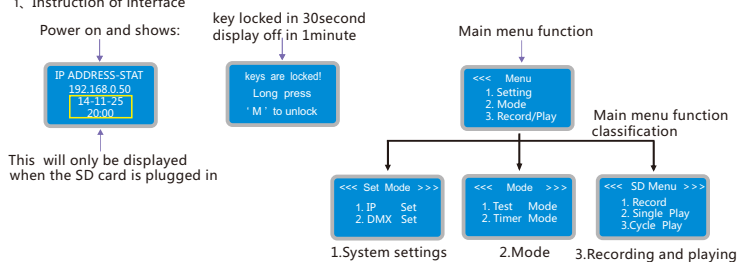

2. Menu function

Press M key to enter the Settings menu, Press the key ▲▼ move the cursor to the target position, tap the M key to enter the corresponding setting page. The following table shows a brief introduction to the Settings menu.

No	Setting	OLED display	Value
1	System setup	Setting	IP setting , DMX settings
	IP setup	IP Type	IP address type settings
		STATIC DHCP	STATIC IP address,DHCP IP address setting
		IP Address	Static IP(default):192.168.0.50 (default):255.255.255.0
	DMX output setup	DMX Set	DMX settings
		DMX 1	Outputs:1-4
		OUTPUT:ON	On : output OFF : no output
2	Mode	Test mode and time setting	
	Test Mode	Test mode,25 built-in test mode	
	Timer Mode	Timer mode contains 8 timers and current time Settings	
3	Record/Play	Recording and play options	
	Record	SD recording effect	
	Loop Play	Single mode loop play	

3

4、Parameter Setting

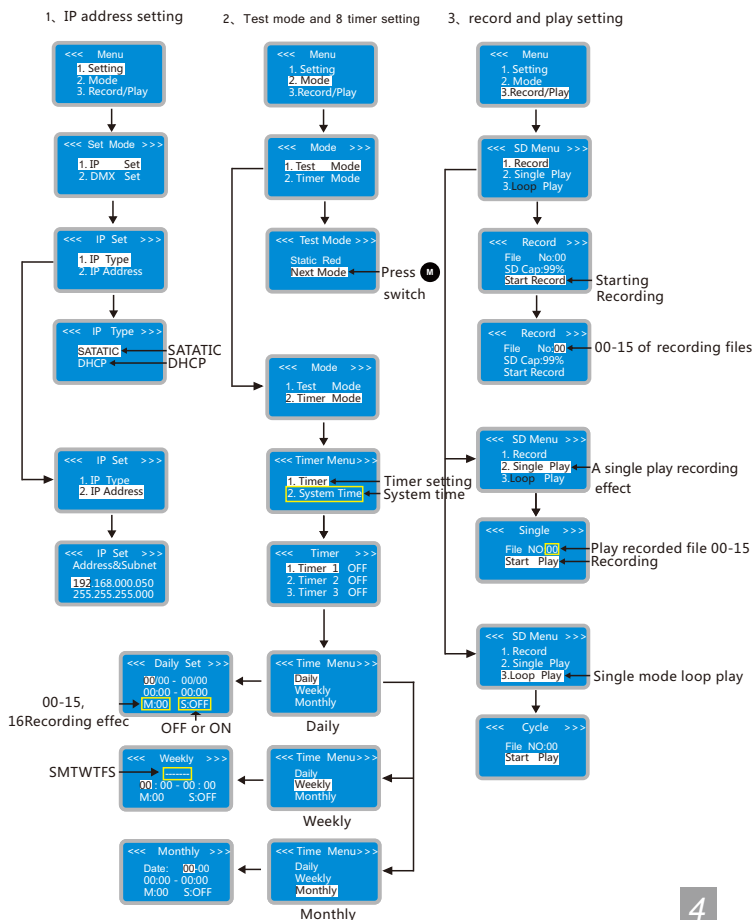

4

4. DMX512 output setting

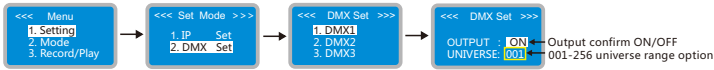

5. WEB setting, Firmware upgrading online

1. In addition to set parameters by keys, you can also set it through the Web browser of computer. The parameter settings between the two are the same;

Open the web browser of the computer, which is in the same LAN with the controller, input the IP address (such as the default IP: 192.168.0.50), and press "Enter" to browse the controller's built-in website, as shown below:



Enter the default password: 12345. Click 'Login' to enter the parameter setting

2. Parameter Setting

4 Port Ethernet to DMX Controller - IP Address 192.168.0.50 [Logout]

ABOUT
Device ID: 04294967 Device name: Ethernet-DMX4 [Set]

Change Password
Current Password: []
Enter New Password: []
Confirm New Password: []
[Set] ← Confirm
Notes: The maximum length of password is 5.

IP Address Assignment Method
Type of IP: DHCP (From Network DHCP Server) Static / Fixed (enter address below)
Static IP Address: [192.168.0.50]
Static IP Address Subnet: [255.255.255.0]
[Set] ← Confirm
Update IP Addressing Information
Notes: It is generally recommended to configure your controller with a static IP address as a DHCP assigned address can change over time. The Static IP address should not be the same IP address as your computer or any other device on your local network.

Test Mode Configuration

Mode Selection: [2 STATIC RED] Enabled: ← Select a good effect and turn it on
[Update Test Mode Information] ← Reconfirm
Notes: To turn on the test mode, the enable item must be selected.

E1.11 RS-485/DMX512 Output Configuration

Output 1 Enabled: DMX Universe: [1]
Output 2 Enabled: DMX Universe: [1] ← select universe 1-256
Output 3 Enabled: DMX Universe: [1]
Output 4 Enabled: DMX Universe: [1]
[Set] ← Final confirm

Play

Play record effect [] File No: [R00] Play type: [Single Play] Start Stop [Set]

System Time Setting

系统时间设置 → Date(Y/M/D): [21/06/02] Time(HH:MM): [16:13] [Set]

Timer1

Timer setting → First step: ON → ON: OFF: [Set] ← Second step: enter setup

Timer2

ON: OFF: [Set]

Timer3

ON: OFF: [Set]

Timer4

ON: OFF: [Set]

Timer5

ON: OFF: [Set]

Timer6

ON: OFF: [Set]

Timer7

ON: OFF: [Set]

Timer8

ON: OFF: [Set]

Timer Setting
 Daily Start day(MM/DD): [00/00] End day(MM/DD): [00/00]
 Weekly Sun: Mon: Tue: Wed: Thu: Fri: Sat:
 Monthly Start day: [31] End day: [1]
Time(HH:MM): [00:00] File No: [R00]
[set] ← Final confirmation
Third step: Set parameters after pop-up setting page

3. Firmware Update

If you need a firmware update, please contact the manufacturer to upgrade the firmware provided by the manufacturer

Firmware Update
Currently Installed Firmware Version: 1.00 / 01-Mar-2021
[After downloading updated firmware to Computer - Click to Update Firmware] ← enter into firmware updating page
Note: If your controller is operating properly or have not been instructed by BINCOLOR to update the firmware, we recommend against updating the firmware.

Please specify a binary file to update the firmware:
[选择文件] [未选择文件] [Update] ← Confirm the upgrade
Select File firmware upgrade file
[Update Firmware Press M Cancel] ← It displays the updated page
If not, please click on the "Back": [Back] ← Return to the main page without upgrading or press the controller key to cancel upgrading

4. Load default

Press the [] button at the same time, and power up the controller, and then release the [] button when the recovery interface appears

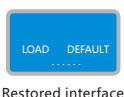

Restored interface

7. Conjunction Diagram

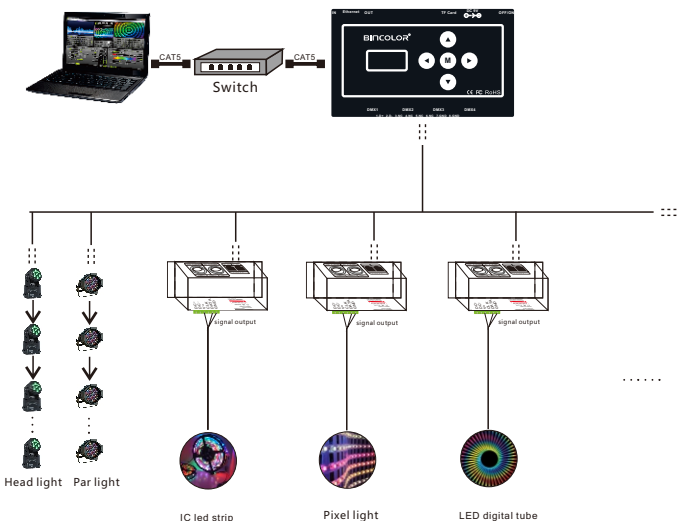

8. After-sales

From the day you purchase our products within 3 years, if being used properly in accordance with the instruction, and quality problems occur, we provide free repair or replacement services except the following cases:

1. Any defects caused by wrong operations.
2. Any damages caused by inappropriate power supply or abnormal voltage.
3. Any damages caused by unauthorized removal, maintenance, modifying circuit, incorrect connections and replacing chips.
4. Any damages due to transportation, breaking, flooded water after the purchase.
5. Any damages caused by earthquake, fire, flood, lightning strike etc force majeure of natural disasters.
6. Any damages caused by negligence, inappropriate storing at high temperature and humidity environment or near harmful chemical.