

# D3-F DMX/RDM CV Decoder



D3-F with the standard RDM remote device management protocol, supports DMX512 signal bi-directional communication, achieves remote management of reading and writing DMX address (DMX master controller must recognize the RDM protocol). Realize 0-100% dimming or different lighting effect; workable with single color, bi-color, RGB LED lamps.

## 1. Product Parameter:

D3-F

Input Signal: DMX512, RDM	Protection: Short circuit/Over current protection
Input Voltage: 5-24Vdc	Working Temp.: -25°C~55°C
Current Load: 6A×3CH Max. 18A	Dimensions: L175×W42×H33mm
Output Power: 90W@5V 216W@12V 432W@24V	Package Size: L183×W48×H41mm
DMX512 Socket: Green Terminal	Weight(G.W.): 310g

## 2. Configuration Diagram:

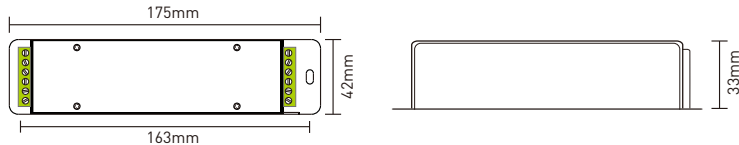

## 3. Dip Switch Operation:



**RDM Mode:** The dip switch 1-10 are OFF.

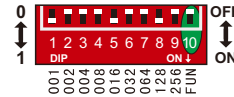

**DMX Mode:** FUN=OFF (the 10th dip switch=OFF)  
Setting DMX addresses with dip switch 1-9

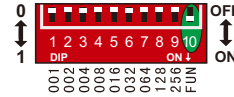

**Self-testing Mode:** FUN=ON (the 10th dip switch=ON)

### 3.1 How to set DMX address via dip switch:

**FUN=OFF** (the 10th dip switch=OFF) **DMX Mode**

DMX address value = the total value of {1-9}, to get the place value when "on" position, otherwise will be 0.

E.g.1: Set Initial Address To 32. E.g.2: Set Initial Address To 37. E.g.3: Set Initial Address To 178.

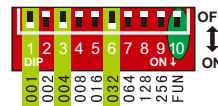
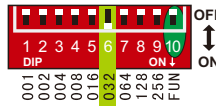

$001+004+032=37$

$002+016+032+128=178$

### 3.2 Self-testing Mode:

**FUN=ON** (the 10th dip switch=ON) **Self-testing Mode**

Dip Switch	1-9=off	1=on	2=on	3=on	4=on	5=on	6=on	7=on	8=on	9=on
Self-test Function	Static Black	Static Red	Static Green	Static Blue	Static Yellow	Static Purple	Static Cyan	Static White	7 Colors Jumping	7 Colors Smooth

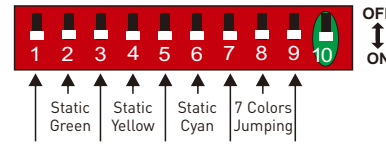

Static Red    Static Blue    Static Purple    Static White    7 Colors Smooth

**OFF** / **ON**  
For changing effects (Dip Switch 8/9=on):  
DIP switch 1-7 is used to realize 7 speed levels. (7=on, the fastest level)

[Attn] When several dip switches are on, subjected to the highest switch value.

As the figure above shows, the effect will be 7 colors smooth at 7 speed level.

4. Wiring Diagram:

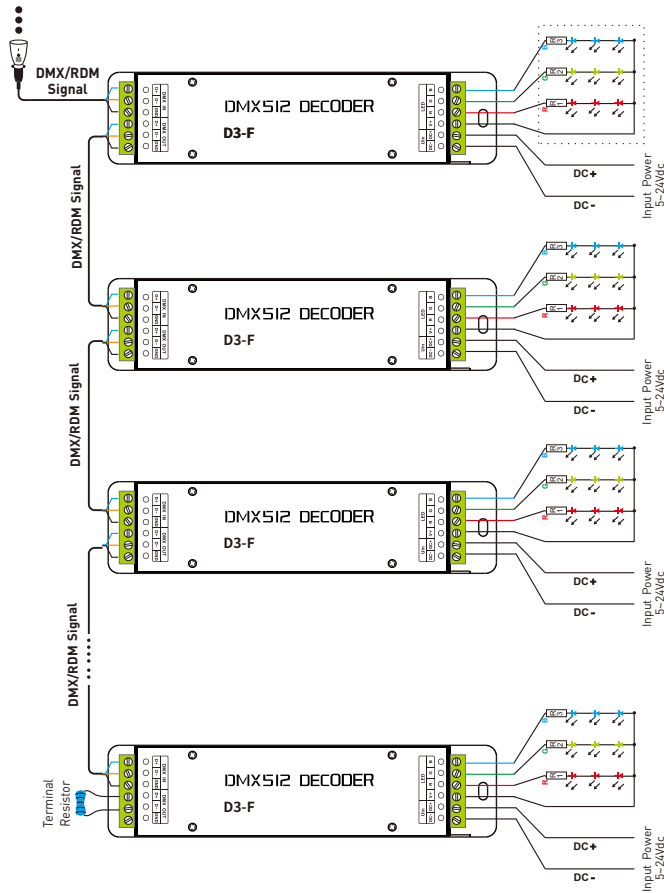

- \* An amplifier is needed when more than 32 decoders are connected, signal amplification should not be more than 5 times continuously.
- \* If the recoil effect occurs because of longer signal line or bad line quality, please try to connect 0.25W 90-120Ω terminal resistor at the end of each line.

6. Attention:

- This product must be installed and adjusted by a qualified professional.
- LTECH products are and not lightningproof non-waterproof (special models excepted). Please avoid the sun and rain. When installed outdoors, please ensure they are mounted in a water proof enclosure or in an area equipped with lightning protection devices .
- Good heat dissipation will prolong the working life of products. Please ensure good ventilation.
- Please check if the working voltage used complies with the parameter requirements of products.
- The diameter of wire used must be able to load the light fixtures you connect and ensure the firm wiring.
- Before you power on products, please make sure all the wiring is correct in case of incorrect connection that causes damage to light fixtures.
- If a fault occurs, please do not attempt to fix products by yourself. If you have any question, please contact your suppliers.

7. Warranty Agreement:

- 5 years warranty from the date of manufacture.
- Free repair or replacement services for quality problems are provided within warranty periods.

7.1 Warranty exclusions below:

- Following conditions are not within the guarantee range of free repairing or replacement services:
  - Beyond warranty periods.
  - Any artificial damage caused by high voltage, overload, or improper operations.
  - Products with severe physical damage.
  - Damage caused by natural disasters and force majeure.
  - Warranty labels and barcodes have been damaged.

7.2 No any contract or invoice signed by LTECH .

Repair or replacement provided is the only remedy for customers. LTECH is not liable for any Incidental or consequential damage unless it is within the law.

7.3 LTECH has the right to amend or adjust the terms of this warranty. The warranty that issues in writing shall prevail.

- ★ This manual is subject to changes without further notice.Product functions depend on the goods. Please feel free to contact our distributors if you have any question.