

LED Intelligent Driver (constant voltage)

- Dimming interface: DMX512/RDM, Push DIM
- Supports RDM remote device management protocol.
- Dimming range from 0-100%, LED start at 0.1% possible.
- With soft-on and fade in function, visual more comfortable.
- 0-100% flicker-free, High frequency exemption level.
- In line with the EU energy efficiency ERP directive, standby power consumption < 0.5W
- Innovative thermal management technology, intelligent power life protection.
- Over-heat / Over voltage / Over load / Short circuit protection, recover automatically.
- Fully-protected plastic housing with design of dismantlable end cover.
- Suitable for indoor I / II / III type lamps application.
- 5 years warranty (Rubycon capacitor).



Flicker-free
IEEE 1789
Achieve the exemption level.



Dimmable:
0.1%-100%

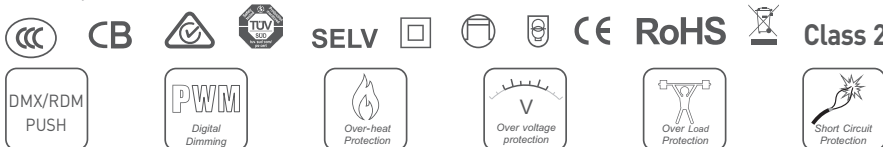

Specification

Model	LM-75-12-G1M2	LM-75-24-G1M2	LM-100-24-G1M2	
OUTPUT	Output Voltage	12Vdc	24Vdc	
	Output Voltage Range	12Vdc ±0.5Vdc	24Vdc ±0.5Vdc	
	Output Current	Max. 6.25A	Max. 3.125A	Max. 4.17A
	Output Power	Max. 75W		Max. 100W
	Output Power Range	0~75W		0~100W
	Strobe Level	High frequency exemption level.		
	Dimming Range	0-100%, dimming depth: Max. 0.1%		
	Overload Power Limitation	≥102%		
	Ripple & Noise	≤200mV	≤300mV	
PWM Frequency	3600Hz			
INPUT	Dimming Interface	DMX/RDM, Push DIM		
	Input Voltage	220-240Vac		
	Frequency	50/60Hz		
	Input Current	Max. 0.4A/230Vac		Max. 0.5A/230Vac
	Power Factor	PF>0.97/230Vac, at full load		
	THD	≤14% at 230Vac, at full load		
	Efficiency (typ.)	91%	92%	93%
	Standby Power Loss	<0.5W		
	Inrush Current(typ.)	Cold start 30A at 230Vac (twidth=1000µs measured at 50% (peak))		Cold start 45.2A at 230Vac (twidth=372µs measured at 50% (peak))
Control surge capability	L-N:2KV			
Leakage Current	Max. 0.5mA			
ENVIRONMENT	Working Temperature	ta: -20°C ~ 50°C tc: 80°C		
	Working Humidity	20 ~ 95%RH, non-condensing		
	Storage Temp., Humidity	-40°C ~ 80°C, 10~95%RH		
	Temp. Coefficient	±0.03%/°C (0-50°C)		
	Vibration	10~500Hz, 2G 12min./1cycle, period for 72min. each along X, Y, Z axes.		
PROTECTION	Over-heat Protection	Intelligently adjusting or turning off the output current if the PCB temperature ≥110°C, auto recovers.		
	Over Voltage Protection	Shut down the output when non-load voltage ≥13V, re-power on to recover after fault condition is removed.	Shut down the output when non-load voltage ≥26V, re-power on to recover after fault condition is removed.	
	Over Load Protection	Shut down the output when current load ≥102%, auto recovers.		
	Short Circuit Protection	Shut down automatically if short circuit occurs, auto recovers.		
SAFETY & EMC	Withstand Voltage	I/P-O/P: 3750Vac		
	Isolation Resistance	I/P-O/P: 100MΩ/500VDC/25°C/70%RH		
	Safety Standards	IEC/EN61347-1, IEC/EN61347-2-13		
	EMC Emission	EN55015, EN61000-3-2 Class C, IEC61000-3-3		
	EMC Immunity	EN61000-4-2,3,4,5,6,8,11 EN61547		
Strobe Test Standard	IEEE 1789			
OTHERS	Dimension	293×43×30mm(L×W×H)		
	Packing	296×44×33mm(L×W×H)		
	Weight(G.W.)	300g±10g		

* The driver is suitable for connecting resistor current-limiting LED fixture (e.g. LED strip). The inrush current will be dozens of times increased if connecting built-in constant current IC current-limiting LED fixtures, the driver will activate the overloaded protection (hiccup flickering). When you order, please remark controlling the constant current LED fixture (e.g. MR16 lamp, underground light, LED wall washer, constant current LED strip, etc.), then we can prepare the special programs.

Application of Protective Cover

Wire pressing board:

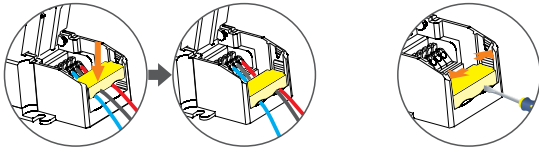

Push the wire pressing board to fix the wire.

Push outward the side plate, meanwhile use the tool to uninstall the wire pressing board.

Uninstall protective cover:

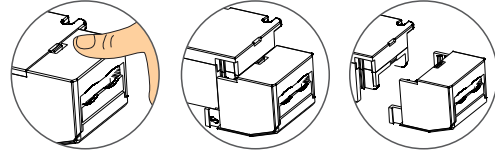

Break off the bottom left and right to remove the protective cover.

DMX Address Setting

The DMX driver can work with the address editor that complies with standard RDM protocol.

It is recommended to use LTECH's RDM editor (model WiFi-RDM01), which can achieve more functions such as remote browsing and parameter setting. Wiring diagram as below:

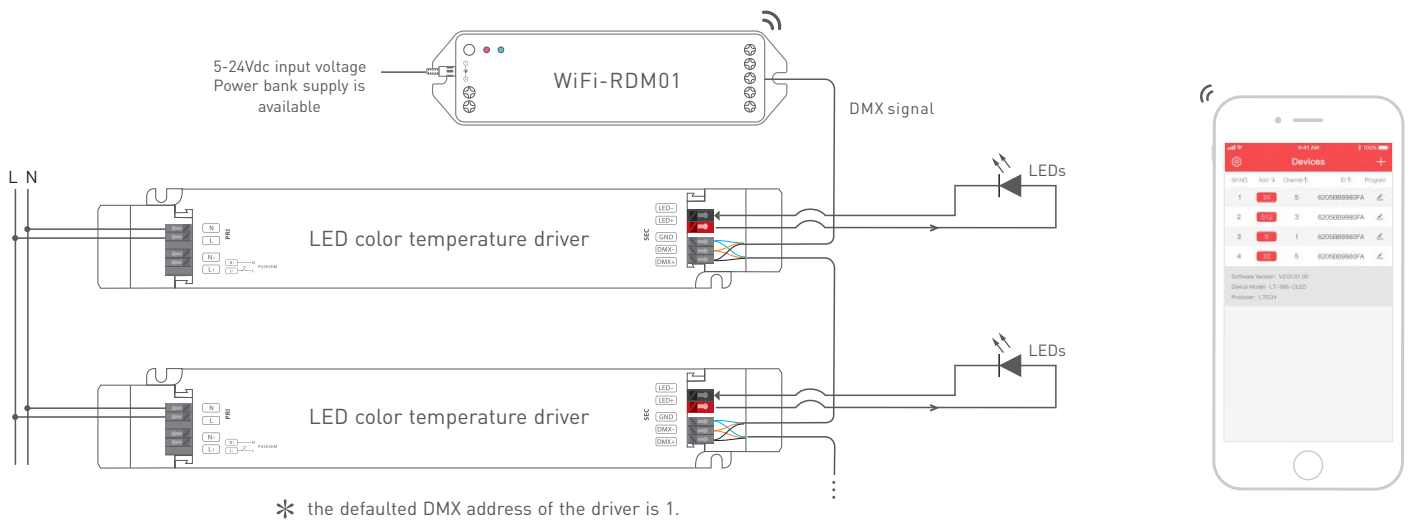

LTECH RDM editor App interface instruction

Download the App, setting the parameters after well connecting the RDM editor, please check the manual of WiFi-RDM01 for more details.

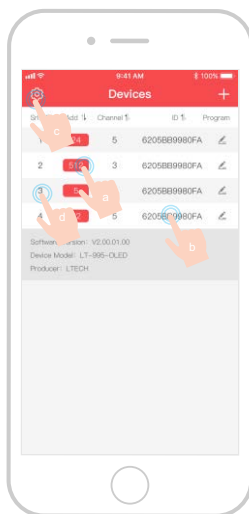

- a: Click "Add", edited the address in corresponding box.
- b: Click "ID", get more product details.
- c: Click "⚙️", enter setting interface
- d: Click "No.", issue the recognizing command.

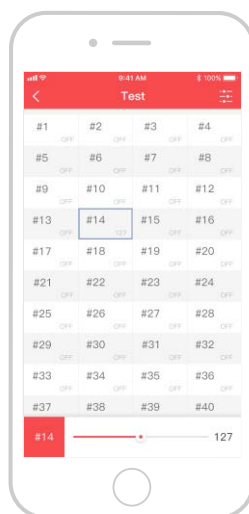

Test

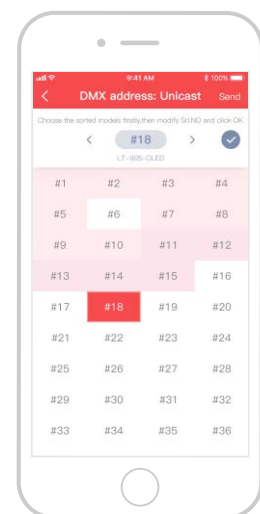

DMX address setting

Relationship Diagrams

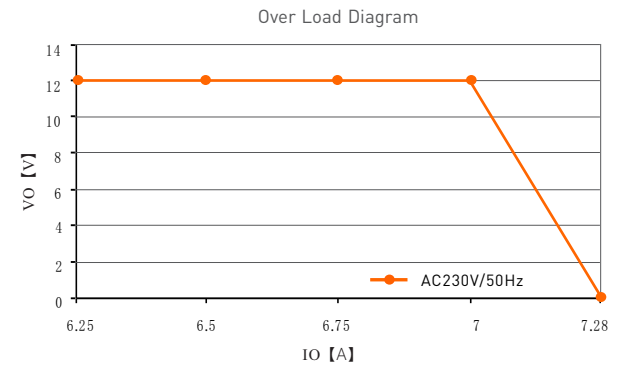
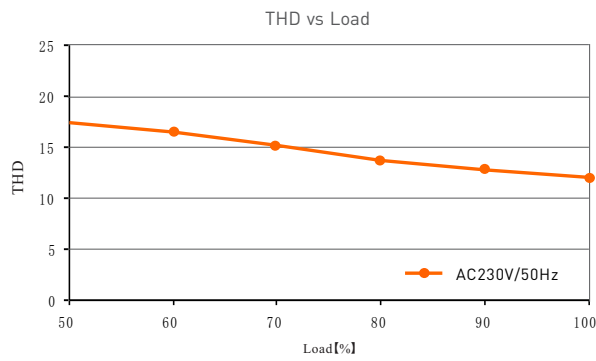
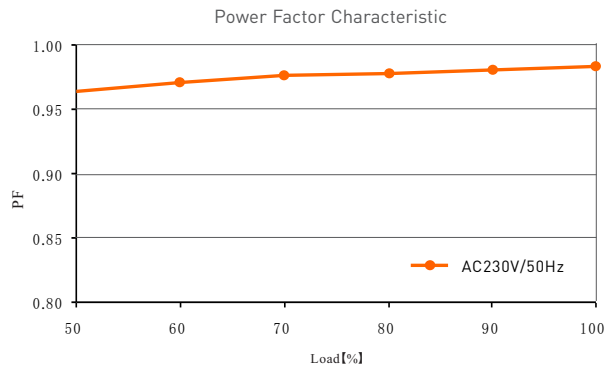
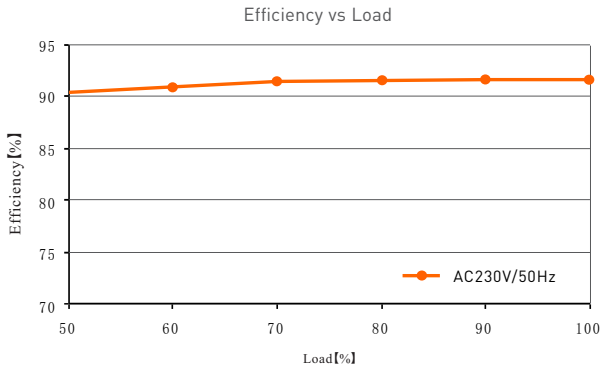

LM-75-12-G1M2

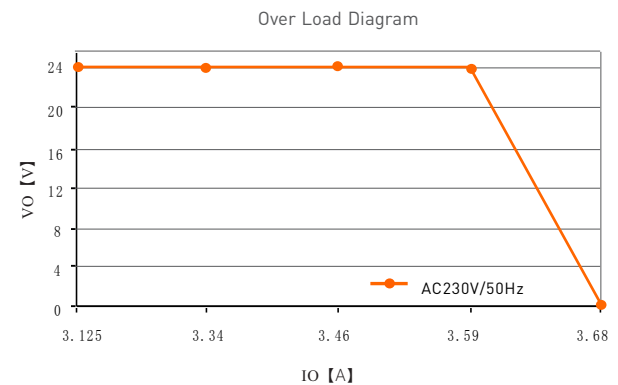
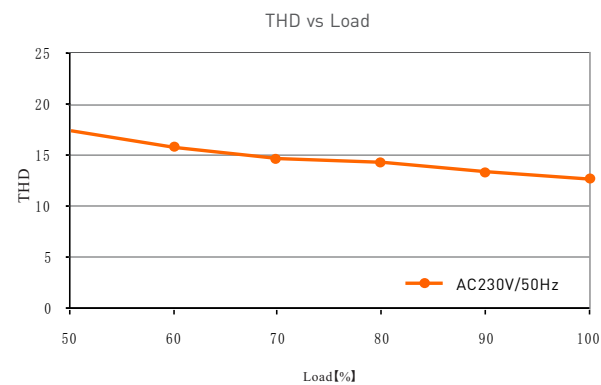
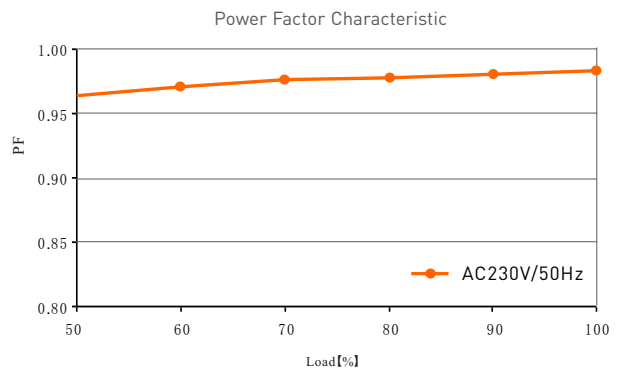
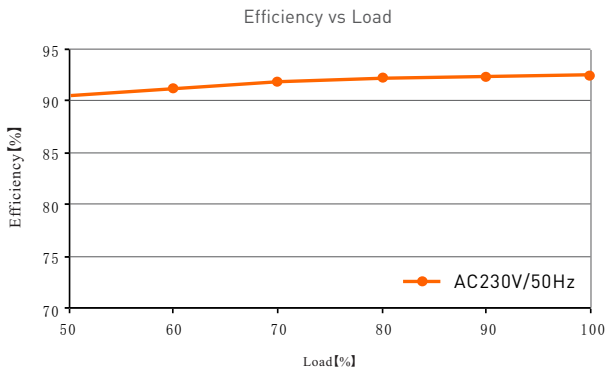

LM-75-24-G1M2

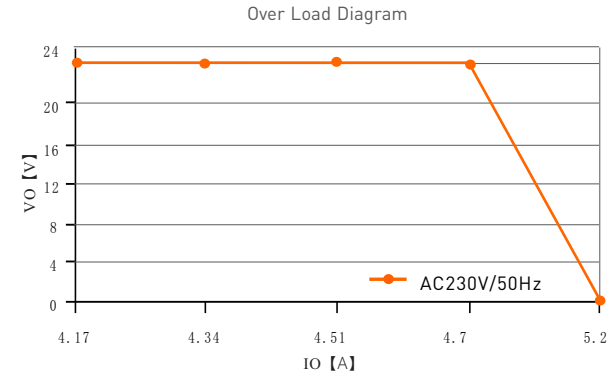
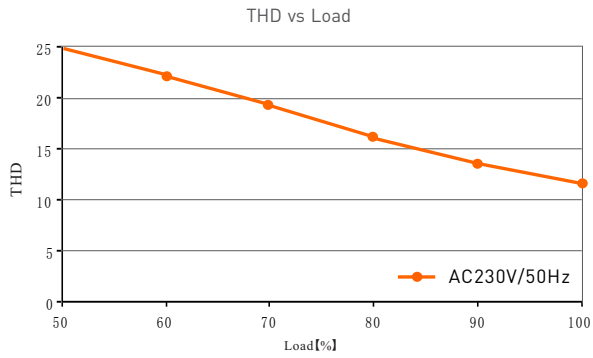
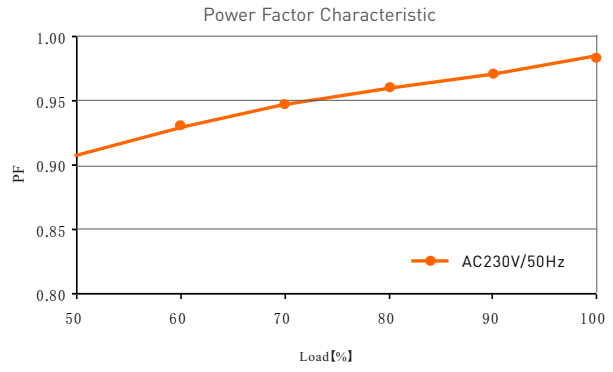
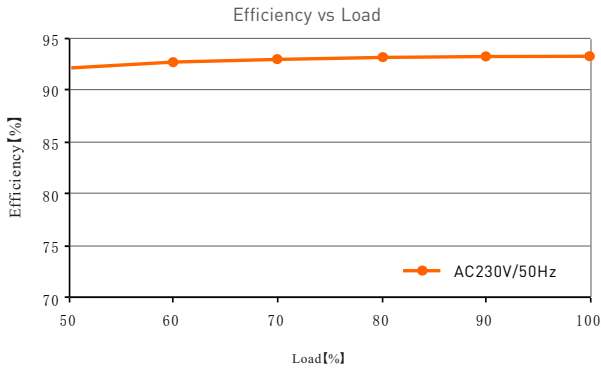

LM-100-24-G1M2

Flicker Test Form

IEEE 1789

Limit of Modulation in low risk area	
Waveform frequency of Optical output	limit [%]
$f \leq 8\text{Hz}$	0.2
$8\text{Hz} < f \leq 90\text{Hz}$	$0.025 \times f$
$90\text{Hz} < f \leq 1250\text{Hz}$	$0.08 \times f$
$f > 1250\text{Hz}$	Exemption assessment
Limit of Modulation in no effect area	
Waveform frequency of Optical output	limit [%]
$f \leq 10\text{Hz}$	0.1
$10\text{Hz} < f \leq 90\text{Hz}$	$0.01 \times f$
$90\text{Hz} < f \leq 3125\text{Hz}$	$(0.08/2.5) \times f$
$f > 3125\text{Hz}$	Exemption assessment (High frequency exemption)

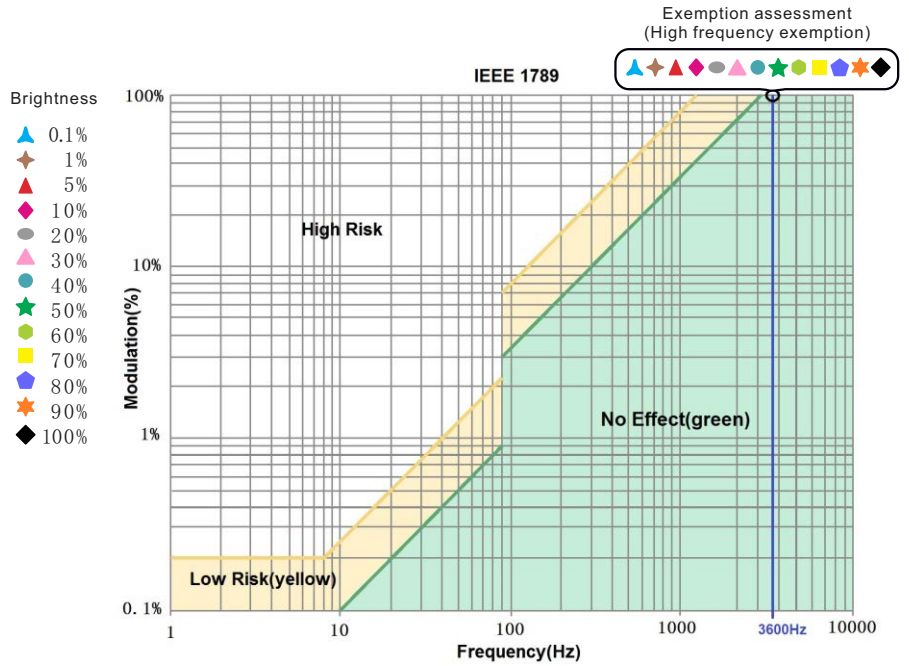

* No further notice if any changes in the manual. Product function depends on the goods. Please feel free to contact your supplier if any question.

LED 智能调光驱动器 (恒压型)

- 调光接口: DMX512/RDM、Push DIM
- 支持RDM远程设备管理协议
- 调光范围: 0~100%, LED从0.1%开始调光
- 带软启动渐亮功能, 让人眼视觉更舒适
- 0-100%全程无频闪, 高频豁免考核级别
- 符合欧盟能效ERP指令, 待机功耗 < 0.5W
- 创新的热管理技术, 智能保护电源寿命
- 过温、过压、过载、短路保护, 可自动恢复
- 全防护塑料外壳电源, 可拆卸端盖设计
- 适合室内 I、II、III类灯具应用
- 5年保修期 (采用红宝石电容)

无频闪
IEEE 1789
高频豁免级别

Dimmable:
0.1%-100%

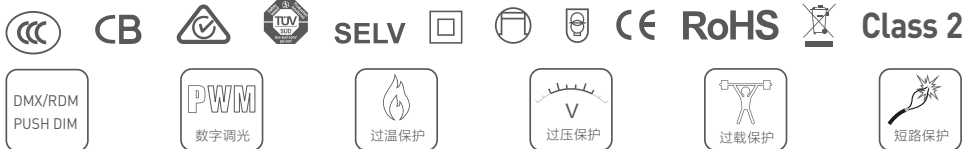
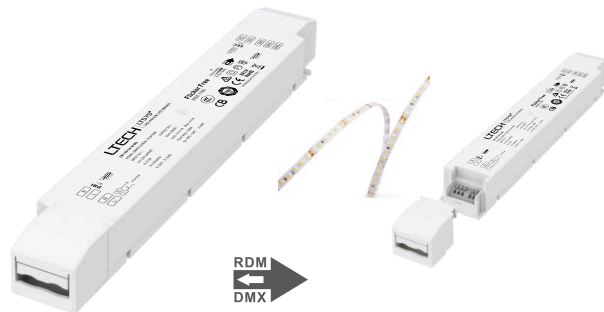

技术参数

型号	LM-75-12-G1M2	LM-75-24-G1M2	LM-100-24-G1M2	
输出	输出电压	12Vdc	24Vdc	
	输出电压范围	12Vdc ± 0.5Vdc	24Vdc ± 0.5Vdc	
	输出电流	Max. 6.25A	Max. 3.125A	Max. 4.17A
	输出功率	Max. 75W		Max. 100W
	输出功率范围	0~75W		0~100W
	频闪级别	高频豁免级别		
	调光范围	0~100%, 调光深度: 0.1%		
	过功率限制	≥102%		
	纹波与噪声	≤200mV	≤300mV	
PWM频率	3600Hz			
输入	调光接口	DMX/RDM, Push DIM		
	输入电压	220-240Vac		
	频率范围	50/60Hz		
	输入电流	Max. 0.4A/230Vac	Max. 0.5A/230Vac	
	功率因素	PF>0.97/230Vac (满载)	PF>0.98/230Vac (满载)	
	谐波THD	230Vac@THD≤14% (满载)	230Vac@THD≤12% (满载)	
	效率 [Typ.]	91%	92%	93%
	待机功耗	< 0.5W		
	浪涌电流	冷启动30A/230Vac	冷启动45.2A/230Vac	
	抗浪涌	L-N: 2KV		
漏电流	Max. 0.5mA			
环境	工作温度	ta: -20 ~ 50°C tc: 80°C		
	工作湿度	20 ~ 95%RH, 无冷凝		
	储存温度 湿度	-40 ~ 80°C, 10~95%RH		
	温度系数	±0.03%/°C(0-50°C)		
	耐振动	10-500HZ, 2G 12分钟/周期, X,Y,Z轴各72分钟。		
保护	过温保护	根据PCB温度超标情况(≥110°C), 智能调节电流输出或关闭, 可自动恢复。		
	过压保护	空载电压 ≥13V, 关闭输出, 异常排除后上电恢复	空载电压 ≥26V, 关闭输出, 异常排除后上电恢复	
	过载保护	负载电流 ≥102%, 关闭输出, 可自动恢复。		
	短路保护	输出线路短路自动关闭, 可自动恢复。		
安规和电磁规格	耐压	输入对输出: 3750Vac		
	绝缘阻抗	输入对输出: 100MΩ/500VDC/25°C/70%RH		
	安全规范	IEC/EN61347-1, IEC/EN61347-2-13		
	电磁兼容发射	EN55015, EN61000-3-2 Class C, IEC61000-3-3		
	电磁兼容抗扰度	EN61000-4-2,3,4,5,6,8,11, EN61547		
	频闪测试标准	IEEE 1789		
其他	产品尺寸	293×43×30mm(L×W×H)		
	包装尺寸	296×44×33mm(L×W×H)		
	产品重量	300g±10g		

* 本款驱动器适合连接电阻限流的LED灯具 (如LED灯条)。如果连接内置恒流IC限流的灯具, 会产生几十倍的瞬间浪涌电流, 导致驱动器会执行过载保护 (打嗝频闪)。下单时这类内置恒流IC限流的灯具需要注明 (如MR16灯杯、地理灯、洗墙灯、恒流硬灯条等), 以便烧写特殊程序。

尺寸图

单位: mm

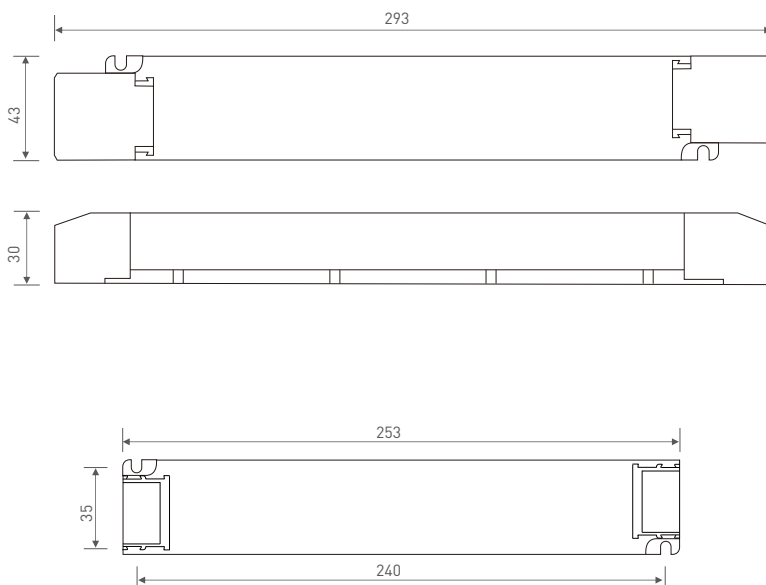

连接应用图

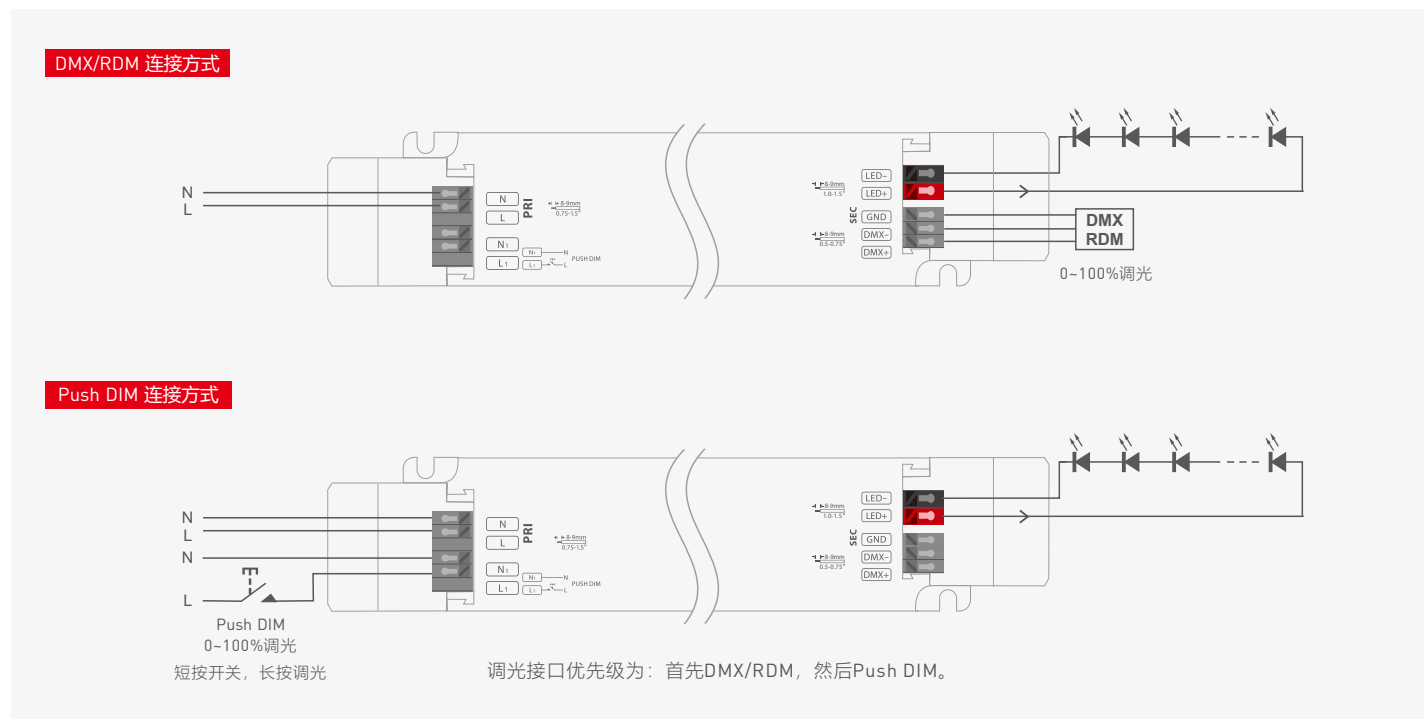

Push Dimming



复位开关

- 开关控制: 短按
- 无级调光: 长按
- 每隔一次长按, 明暗度会向相反方向调整。
- 调光记忆: 当再次开关时, 灯光会回到先前调整的亮度水平。

保护盖应用图

压线板

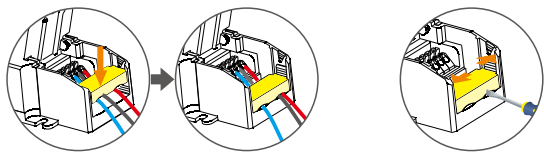

向下推压线板，可固定住线。

向外推侧板的同时，
用工具撬即可拆下压线板。

保护盖的拆装

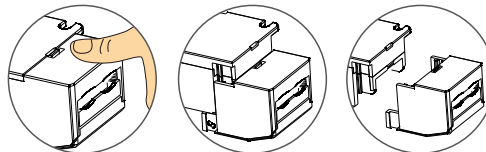

在底部左右撬动，即可将保护盖拆下。

DMX地址设置

DMX电源可以与遵从标准RDM协议的地址编辑器配合使用。

建议使用LTECH的RDM编辑器（型号WiFi-RDM01），可实现手机远程浏览与设置参数等更多功能，连接图如下：

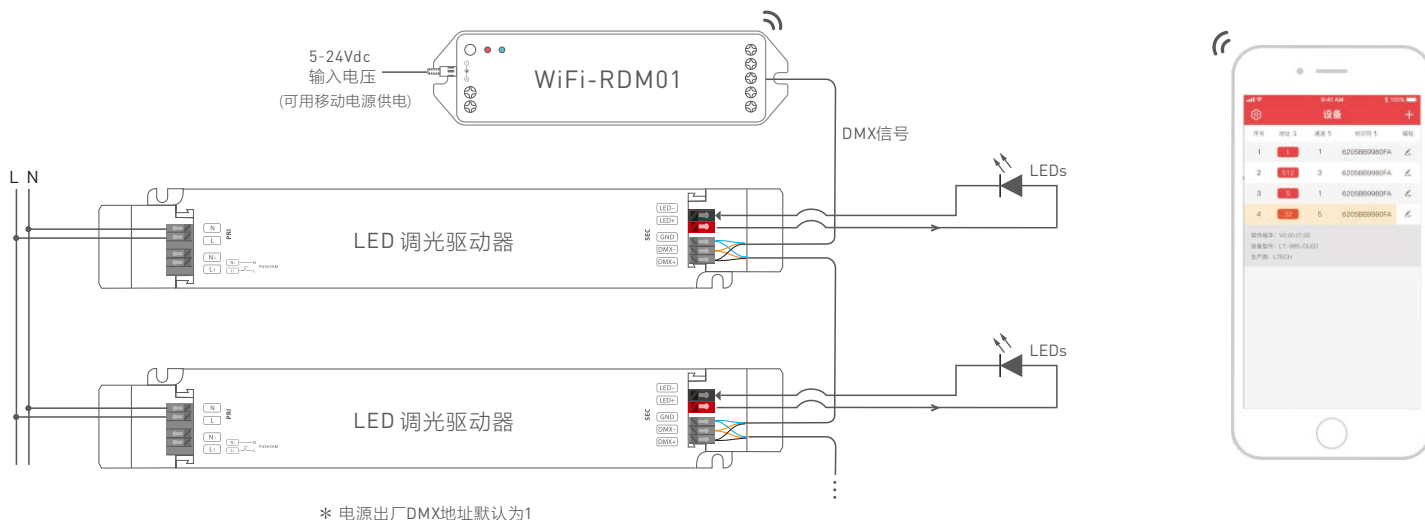

LTECH RDM编辑器APP界面介绍

手机下载APP，与RDM编辑器连接成功后，即可通过APP设置参数，具体请参看WiFi-RDM01的使用说明书。

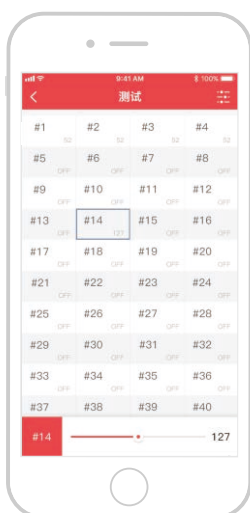
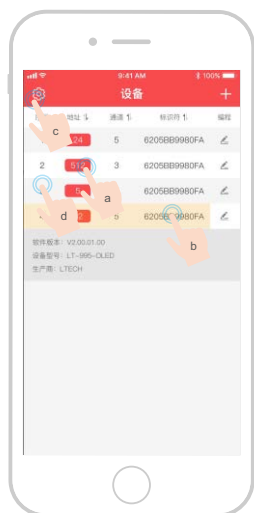

测试

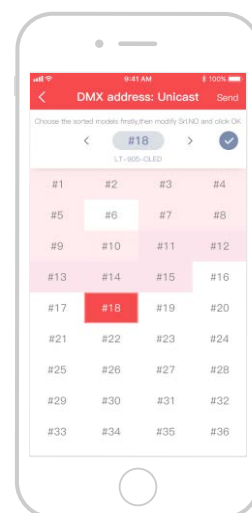

DMX地址设置

- a: 点击“地址”对应方框可编辑地址；
- b: 点击“标识符”出现产品详细信息；
- c: 点击 ⚙️ 按钮，进入设置界面
- d: 点击序号发出识别命令。

关系图表

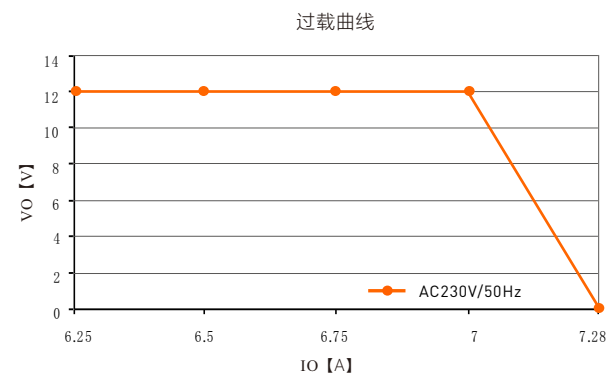
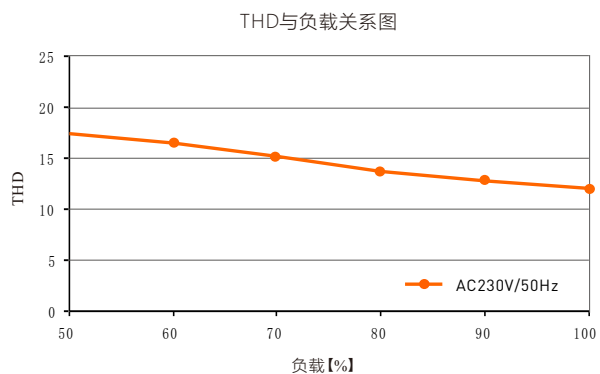
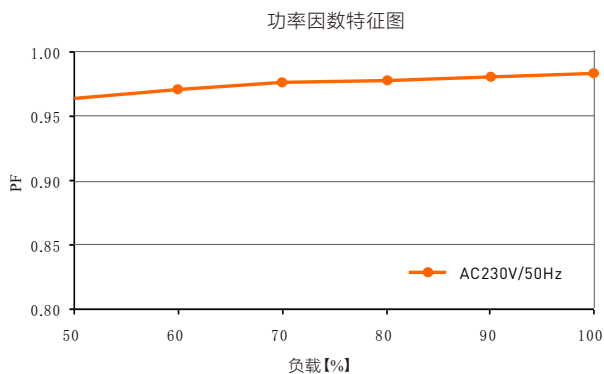
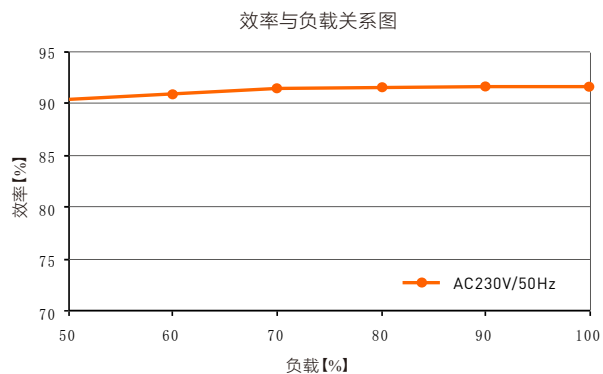

LM-75-12-G1M2

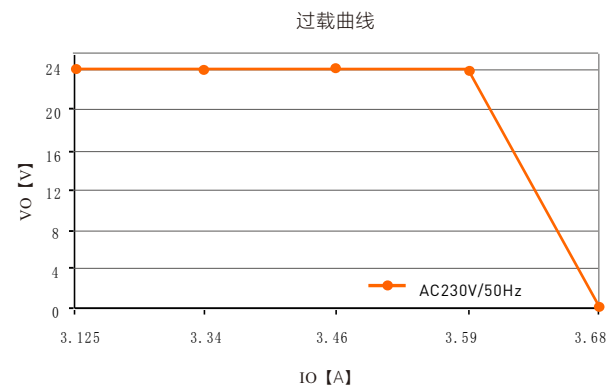
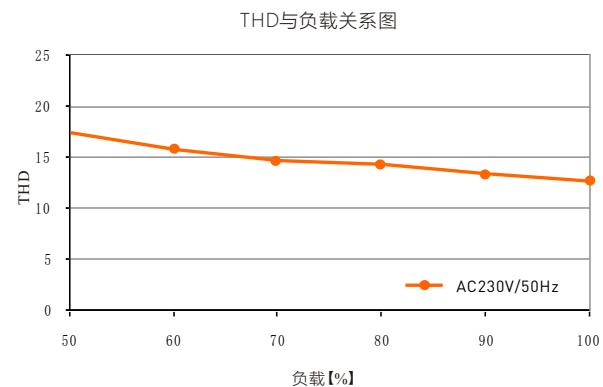
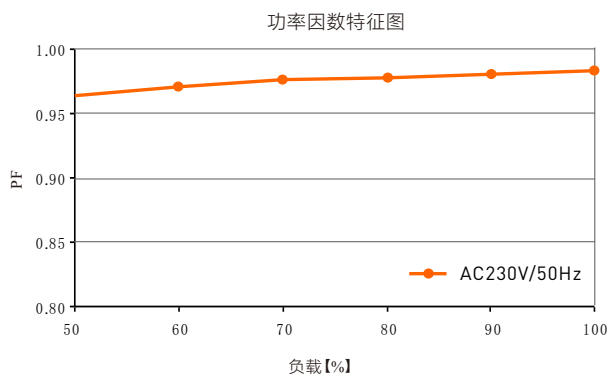
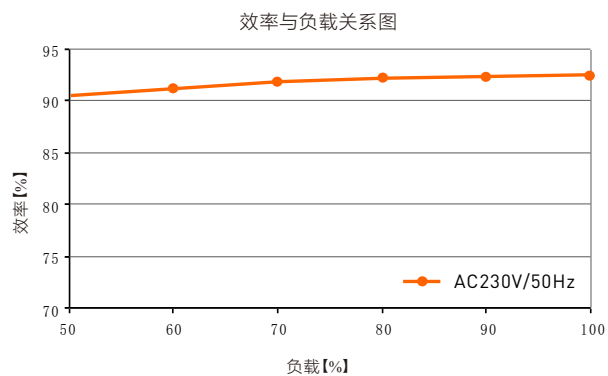

LM-75-24-G1M2

效率与负载关系图

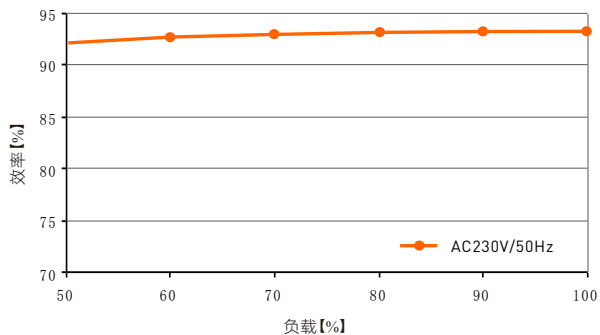

功率因数特征图

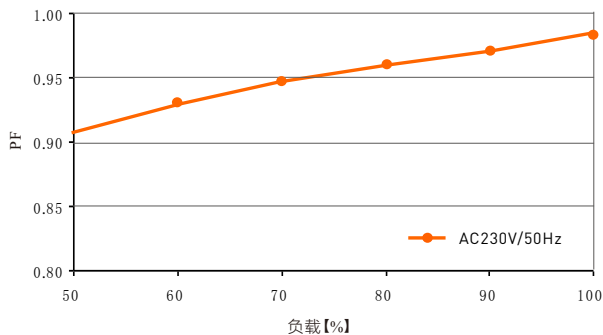

THD与负载关系图

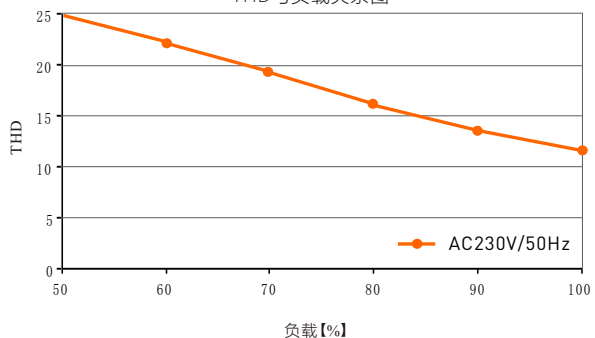

过载曲线

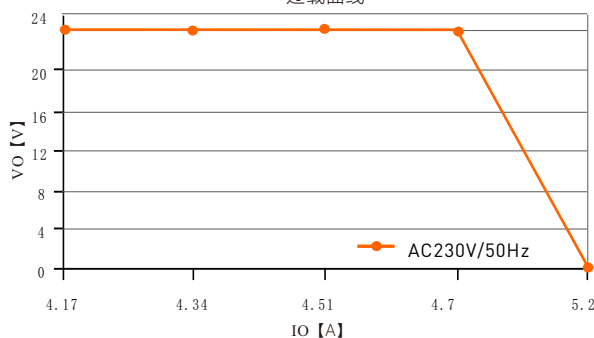

LM-100-24-G1M2

频闪测试表

IEEE 1789

低风险区域 (Low Risk) 的波动深度 (Modulation) 限值	
光输出波形频率 f	限值 (%)
$f \leq 8\text{Hz}$	0.2
$8\text{Hz} < f \leq 90\text{Hz}$	$0.025 \times f$
$90\text{Hz} < f \leq 1250\text{Hz}$	$0.08 \times f$
$f > 1250\text{Hz}$	免除考核
无风险区域 (No Effect) 的波动深度 (Modulation) 限值	
光输出波形频率 f	限值 (%)
$f \leq 10\text{Hz}$	0.1
$10\text{Hz} < f \leq 90\text{Hz}$	$0.01 \times f$
$90\text{Hz} < f \leq 3125\text{Hz}$	$(0.08/2.5) \times f$
$f > 3125\text{Hz}$	免除考核 (高频豁免)

亮度

- ▲ 0.1%
- ◆ 1%
- ▲ 5%
- ◆ 10%
- 20%
- ▲ 30%
- 40%
- ★ 50%
- 60%
- 70%
- 80%
- ★ 90%
- ◆ 100%

免除考核 (高频豁免)

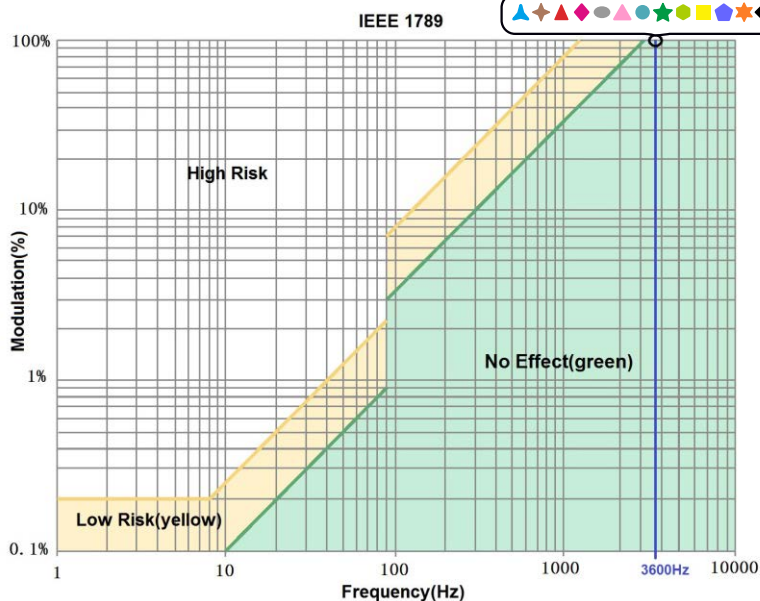

* 本说明书的内容如有变更, 恕不另行通知。若内容与您使用的功能有所不同, 则以实物为准。如有疑问, 请与供应商联系。